











_Top in ceramica, fianchi in metallo.
_Top in ceramic, metal sides.
_Dessus en céramique, panneaux latéraux en métal.
_Keramikabdeckplatte, Seiten aus Metall.
_Top de cerámica, costados en metal.

107_Black (top)
308_Dark (sides)

POWER max	11,5 - 9.890 [kW-kcal/h]
POWER min	3,3 - 2.838 [kW-kcal/h]
	90,8 [%]
	52 [l]
	pellet Ø 6-8 x 5÷30 [mm]
	~ 0,6 / ~ 2,1 [kg/h]
	~ 56 / ~ 17 [h]
	245/40 - 280/35 - 330/30 [m³]
	8 [cm]
	190 [kg]
	10 - 0,10 [Pa- mbar]
	180 [°C]
	min. 2,3 - max 8,3 [g/s]



CE

ART. 15a B-VG EN 14785
BAFA gefördert REGENSBURGER / MÜNCHENER BStB
BlmSchV



V K F A E A I

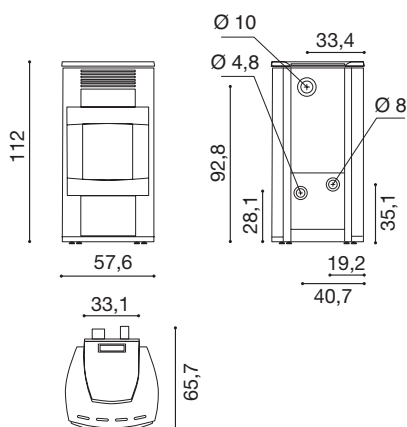

313_Silver













304_Bordeaux



ATHOS HYDRO POWER

_Top in ceramica, fianchi in metallo.
 _Top in ceramic, metal sides.
 _Dessus en céramique, panneaux latéraux en métal.
 _Keramikabdeckplatte, Seiten aus Metall.
 _Top de cerámica, costados en metal.

107_Black (top)
 308_Dark (sides)

POWER max	tot. 23,7 - 20.382 [kW-kcal/h] water 16,2 - 13.932 [kW-kcal/h]
POWER min	tot. 6,2 - 5.332 [kW-kcal/h] water 3,7 - 3.182 [kW-kcal/h]
	92 [%]
	52 [l]
	pellet Ø 6-8 x 5÷30 [mm]
	~ 1 / ~ 5 [kg/h]
	~ 33 / ~ 7 [h]
	510/40 - 582/35 - 679/30 [m³]
	8 [cm]
	200 [kg]
	10 - 0,10 [Pa- mbar]
	250 [°C]
	min. 7,3 - max 13 [g/s]



ART. 15a B-VG EN 14785
 BAFA gefördert REGENSBURGER / MÜNCHENER BStB
 BlmSchV



V K F A E A I

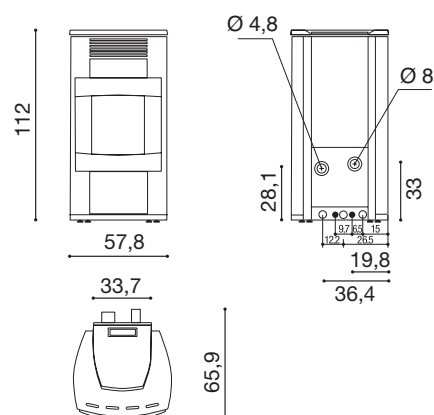

313_Silver



304_Bordeaux

